



VARIO-THERM

FC2-N Hotcupboard

Key features

- Thermostatically controlled convection hotcupboard
 - Temperature range of 30 - 100°C
- 1/1 gastronorm compatible hotcupboard with two shelves
 - Capacity of 4 x 1/1 GN containers
- Removable doors and shelving
 - Makes deep cleaning much easier
- Supplied with 2.5 metre cable
 - 13A coiled cable fitted
- Easy servicing and maintenance
 - Easily accessible quick release fan and element box
- Supplied on braked castors for ease of moving

Additional features:

- Anti-tilt bracket
- Constructed from 430 stainless steel with commercial grade Aluzinc base

Similar Models

- FC3-N - 6 x 1/1 GN Hotcupboard
- FC4-N - 8 x 1/1 GN Hotcupboard

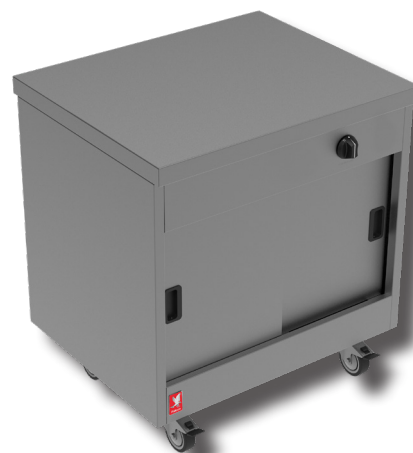

Measurements *in mm*

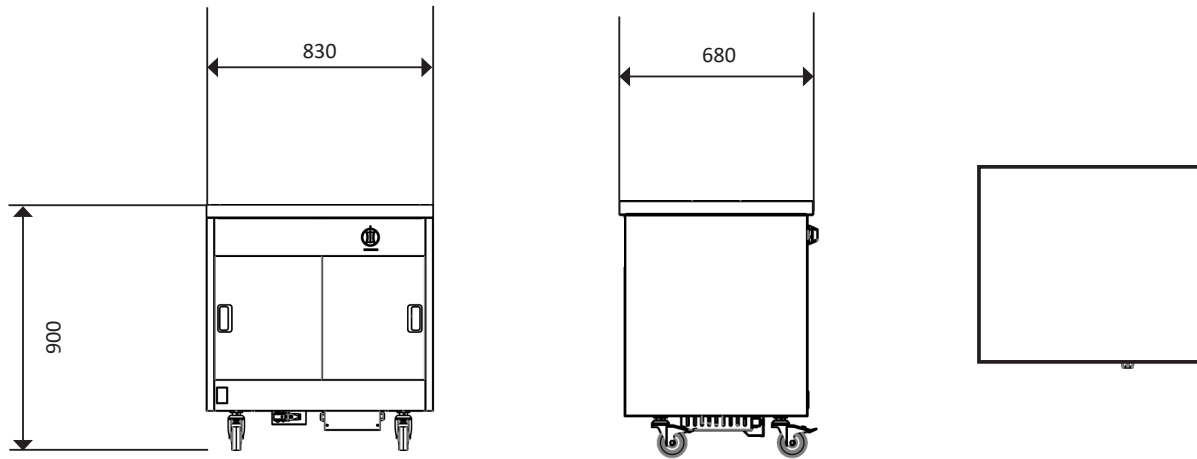

Specification *details*

Electrical rating (kW)	1.5
Electrical supply voltage	230V
Required electrical supply (A)	13
Weight (kg)	87
Packed weight (kg)	107
Packed dimensions (w x d x h - mm)	900 x 850 x 1100

